

Notes: -  
For marine applications, use a silicone sealant or a bedding compound to avoid electrolytic action between the cleat and metal fastenings.

Standard rivet gun nozzles do not fit inside cleat.

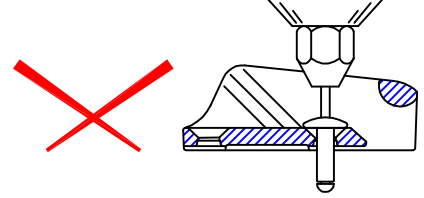

Use 2 or 3 nuts to extend nozzle.

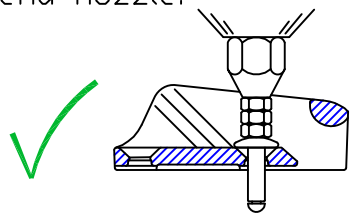

Extended nozzle is best  
Consult rivet gun supplier.

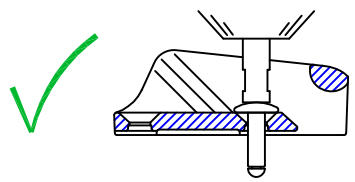

2 Holes  $\phi 4.9$   
countersunk  $\phi 10.0 \times 90^\circ$

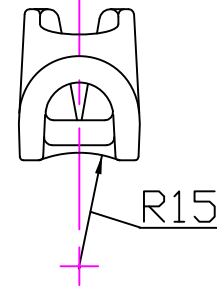

Section 'AA'

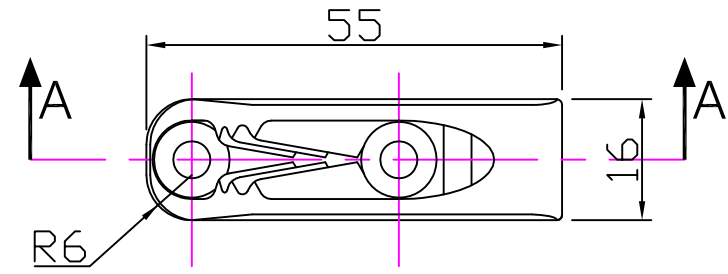
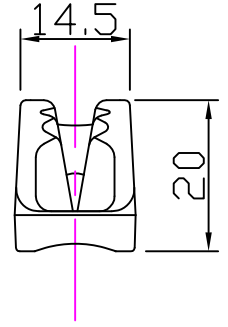
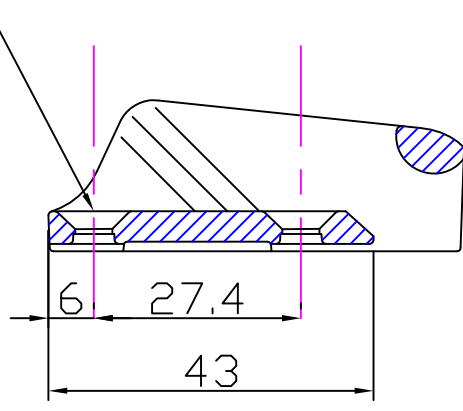

**Clamcleat®**  
Rope cleats

Clamcleats Limited  
Watchmead  
Welwyn Garden City  
Hertfordshire AL7 1AP  
England  
Telephone +44 (0)1707 330101  
Fax +44 (0)1707 321269  
Email sales@clamcleat.com  
www.clamcleat.com

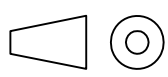

Scale 1:1  
All dimensions in mm.

Issue: 7    April 2010  
ID2112.dwg

Material:  
Diecast Aluminium

Installation Drawing for:-

**CL211 Mk.2**  
Mk2 Racing Junior