

Section 'AA'

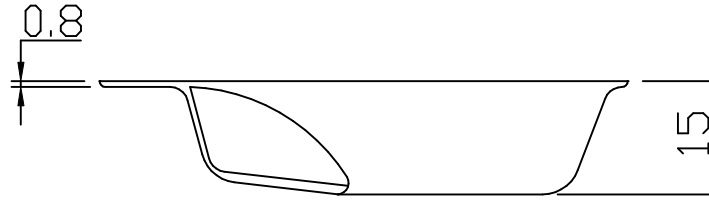

2 Holes  $\varnothing 4.8$

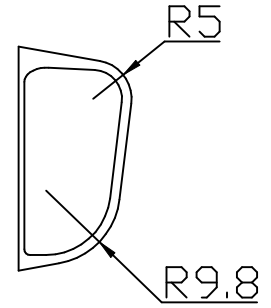
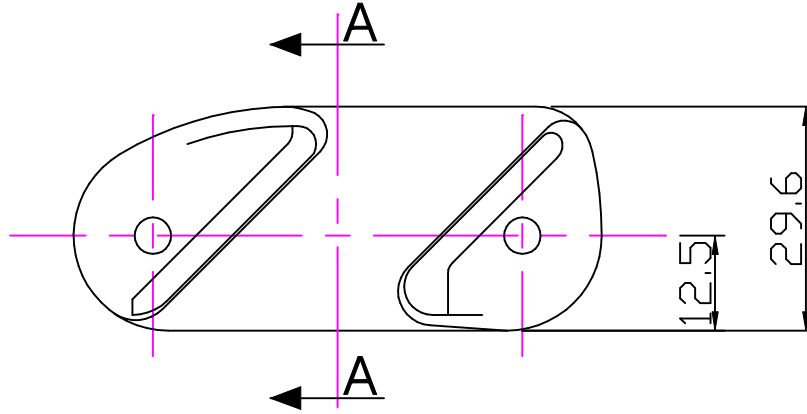
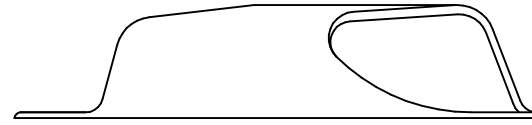
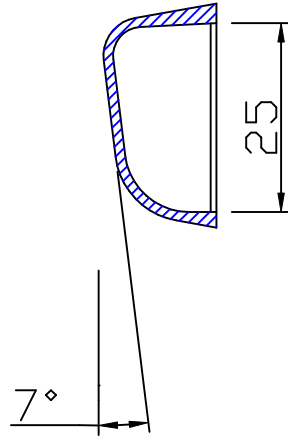
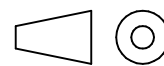
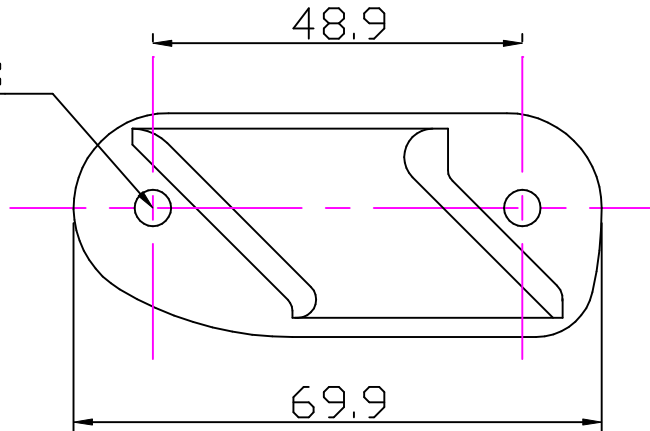

Scale 1:1  
All dimensions in mm.

**Clamcleat®**  
Rope cleats

Clamcleats Limited  
Watchmead  
Welwyn Garden City  
Hertfordshire AL7 1AP  
England

Telephone +44 (0)1707 330101  
Fax +44 (0)1707 321269  
<http://www.clamcleat-rope-cleats.com>

Issue: 1.	May 2002
ID212A.dwg	
Material:	Nylon
Installation Drawing for:-	
<b>CL212A</b>	
Shield for Clamcleat Leech Line Cleat CL212	