

Standard rivet gun nozzles do not fit inside cleat.

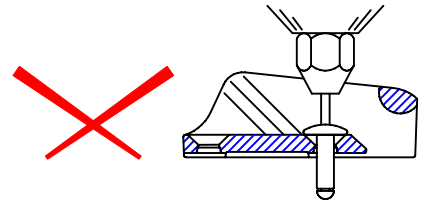

Use 2 or 3 nuts to extend nozzle.

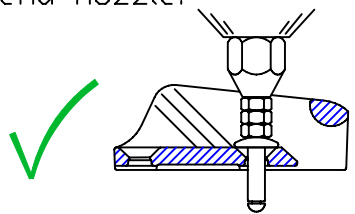

Extended nozzle is best  
Consult rivet gun supplier.

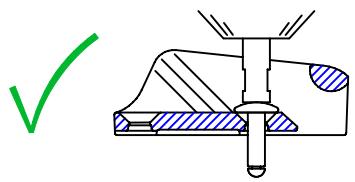

2 Holes  $\varnothing 3.5$   
countersunk  $\varnothing 7.5 \times 90^\circ$

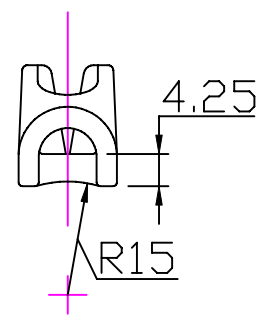

Section 'AA'

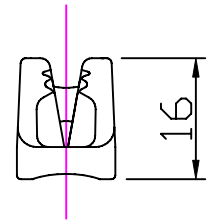
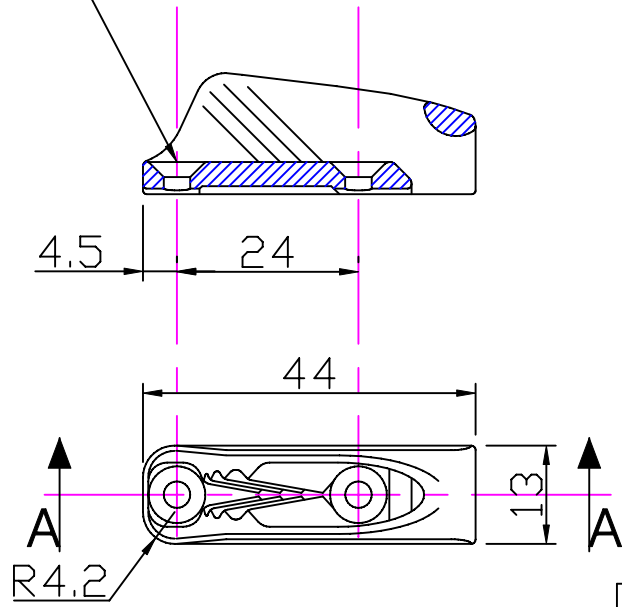

**Clamcleat®**  
Rope cleats

Clamcleats Limited  
Watchmead  
Welwyn Garden City  
Hertfordshire AL7 1AP  
England

Telephone +44 (0)1707 330101  
Fax +44 (0)1707 321269  
<http://www.clamcleat-rope-cleats.com>

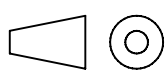

Scale 1:1  
All dimensions in mm.

Issue: 1	June 2006
ID268.dwg	
Material: Diecast Aluminium	
Installation Drawing for:- <b>CL268</b> Racing Micros	