

M4 4/4.2mm  $\phi 3 - 6$ mm  
 #8 (5/32") No.8 1/8"-1/4"

Section 'AA'

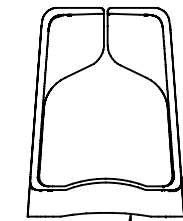

R36

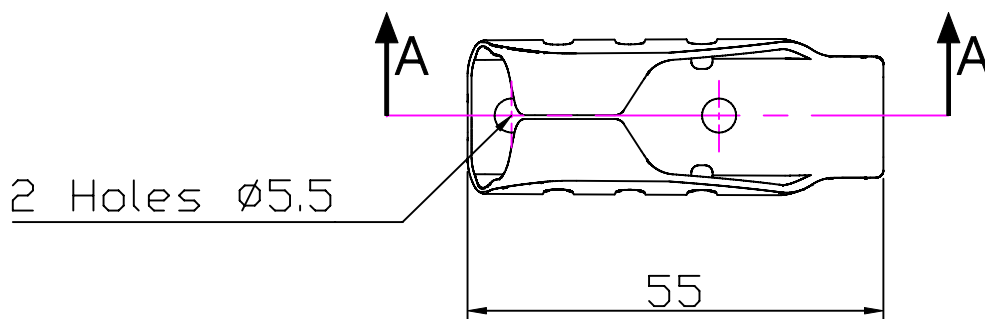
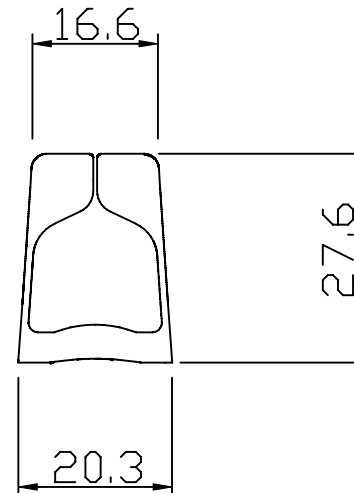
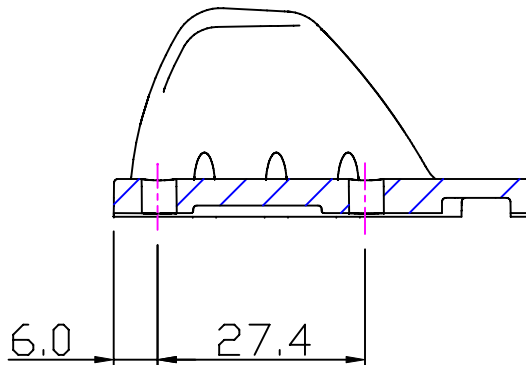

Instructions and compatible cleats on page 2

Issue: 2. May 2006  
 Page1 of 2 ID815.dwg

Material:  
 Acetal

Installation Drawing for:-

**CL815**

Keeper for CL211Mk2

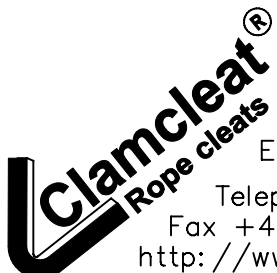

Clamcleats Limited  
 Watchmead  
 Welwyn Garden City  
 Hertfordshire AL7 1AP  
 England

Telephone +44 (0)1707 330101  
 Fax +44 (0)1707 321269  
<http://www.clamcleat-rope-cleats.com>



Scale 1:1  
 All dimensions in mm.

### Rope runs free

Keeper is closed to stop rope going into cleat teeth.

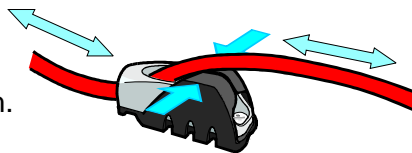

### Pull rope back and down to cleat

Keeper opens to allow rope into teeth

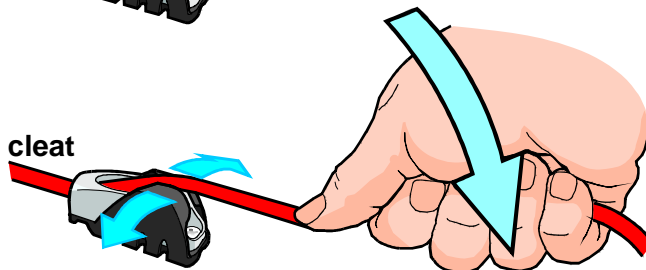

### Rope gripped

Keeper holds rope in cleat

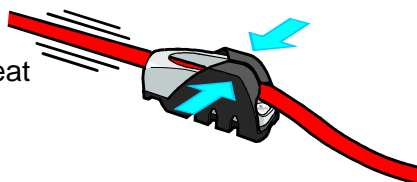

### Lift up to release

Keeper opens to allow rope out of teeth

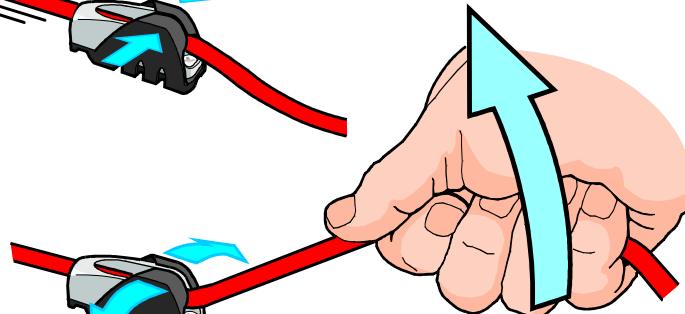



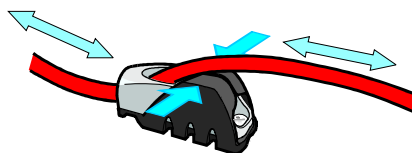

### Rope runs free again

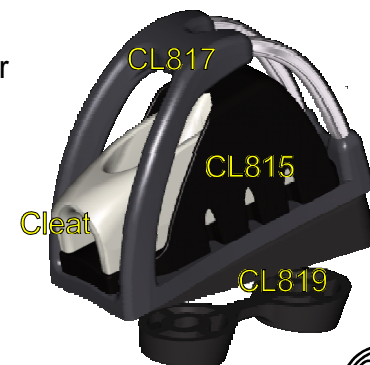

CL815 Keeper can be used with a variety of cleats and other accessories.



Cleat	 Cleat + CL815	 Cleat + CL815 + CL819	 Cleat + CL815 + CL817	 Cleat + CL815 + CL817 + CL819
CL211 Mk2	✓	✓	✓	✓
CL211 Mk2AN	✓	✓	✓	✓
CL211 Mk2/S2	✓	✓		
CL211 Mk2AN/S2	✓	✓		



Clamcleats Limited  
Watchmead  
Welwyn Garden City  
Hertfordshire AL7 1AP  
England

Telephone +44 (0)1707 330101  
Fax +44 (0)1707 321269  
www.clamcleat.com

ID815  
page 2 of 2

Issue 2  
July 2006

Installation Drawing for:-

# CL815

Keeper for Mk2 Racing Juniors